



pui
audio™ inc
a projects unlimited company

AI-3035-TWT-3V-R 30mm Indicator



3541 Stop Eight Road • Dayton, Ohio 45414

Product Overview

- 30mm diameter, 2-5VDC self-drive indicator
- 100 dBA minimum output (3VDC @ 10 cm) and 3,500 Hz continuous tone
- PBT housing withstands Wave soldering temperatures
- Removable wash tag preserves performance

SPL vs Voltage (measured @ 30 cm)

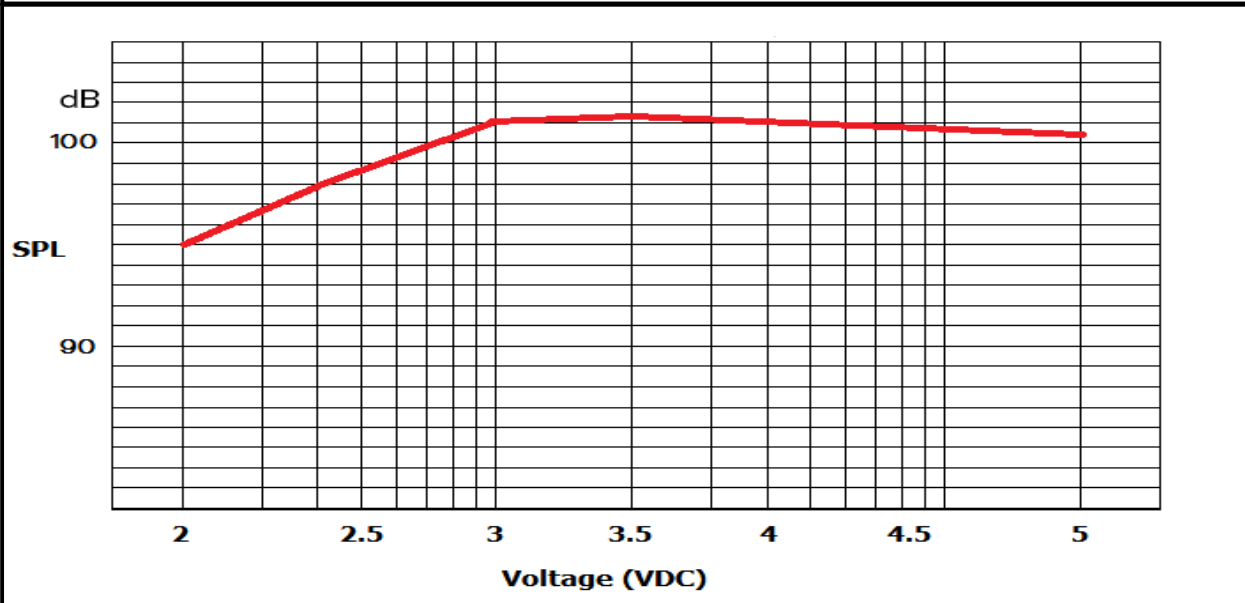

RoHS Compliant



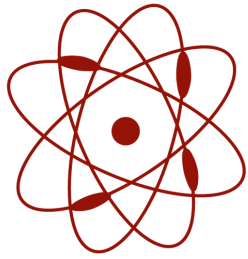

pui audio™ inc
a projects unlimited company

AI-3035-TWT-3V-R 30mm Indicator

Mechanical and Environment Testing

Test Description	Test Condition
High Temperature	+85°C (±2°C) with random humidity for 96 hours
Low Temperature	-30°C (±2°C) with random humidity for 96 hours
Humidity	40°C (±2°C) with 90% to 95% relative humidity for 96 hours
Vibration	0.75 mm movement modulated at 10-55 Hz for 3 hours
Drop Test	100 cm free fall onto wood board, 10 cycles
Temperature Cycle Test	-30°C to 80°C, 100 cycles

After tests, part shall rest for 2 hours. Parts are then tested for clean, pure tones.

Wave Solder Profile

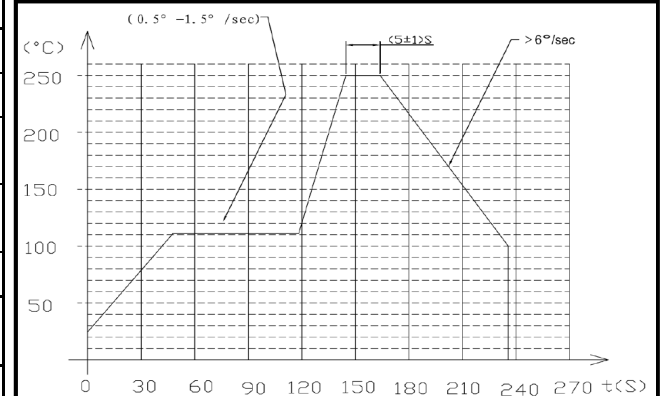

Frequency Response and SPL Measurement Setup

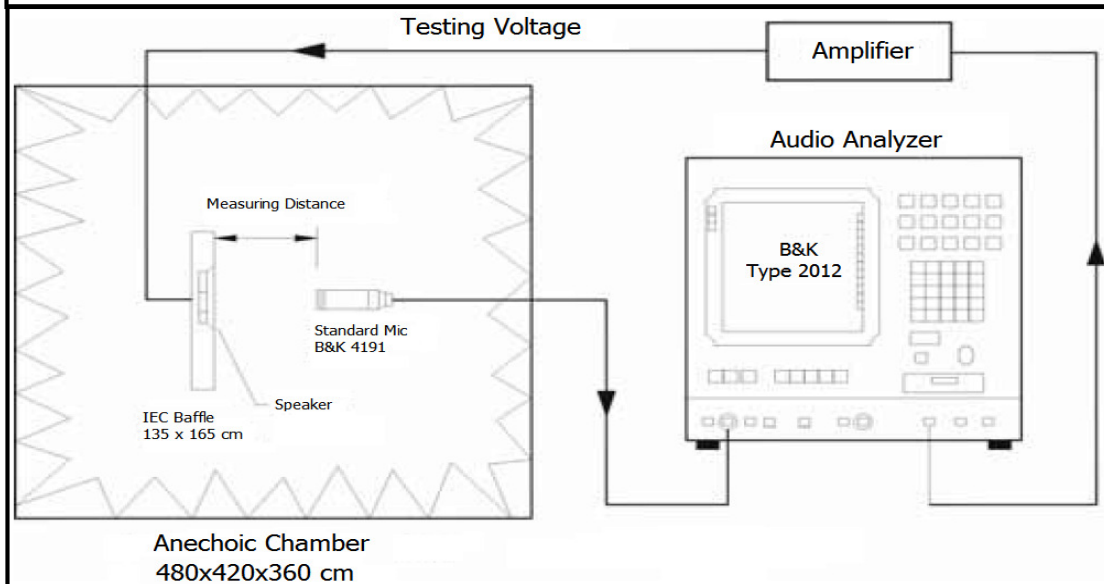

Temperature Cycle Test Graph

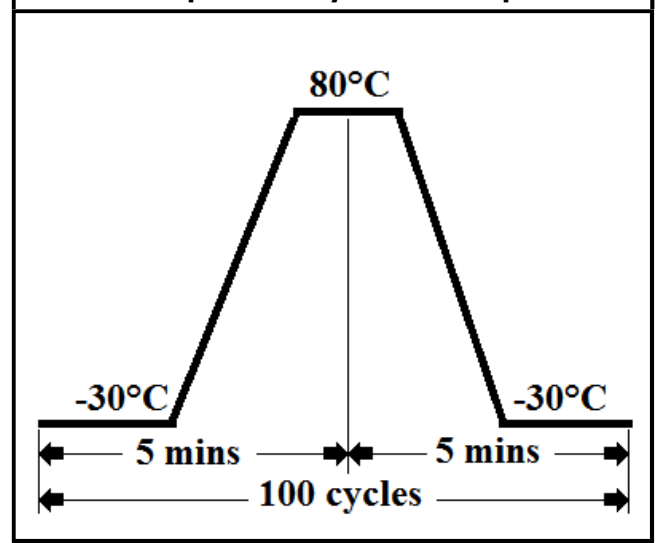

SPECIFICATIONS

PARAMETERS	VALUES	UNITS
RATED VOLTAGE	3	Vdc
OPERATING VOLTAGE RANGE	2 ~ 5	Vdc
RATED CURRENT (MAX)	9	mA
MINIMUM SPL @ 10 CM	100	dBA
RESONANT FREQUENCY	3,500 ± 500	Hz
TONE OR PULSE RATE	CONTINUOUS	0 pulse/sec
OPERATING TEMPERATURE	-20 ~ +80	°C
STORAGE TEMPERATURE	-30 ~ +85	°C
HOUSING MATERIAL	PBT	-
TERMINAL MATERIAL	Sn PLATED COPPER	-
WEIGHT	10	grams

THIS DOCUMENT CONTAINS DATA PROPRIETARY TO PROJECTS UNLIMITED, INC. ANY USE OR REPRODUCTION, IN ANY FORM, WITHOUT PRIOR WRITTEN PERMISSION OF PROJECTS UNLIMITED, INC. IS PROHIBITED.
©2003, Projects Unlimited Inc.

REVISION HISTORY

LTR	DESCRIPTION	DATE	APPROVED
-	RELEASED FROM ENGINEERING	3/22/2006	
A	REVISED BODY HEIGHT DIMENSION	4/18/2008	B.R.
B	REVISED TO INVENTOR 3-D DRAWING TEMPLATE	6/14/2008	B.R.
C	REVISED HEIGHT AND STAND-OFF DIMENSIONS	9/23/2011	M.L.

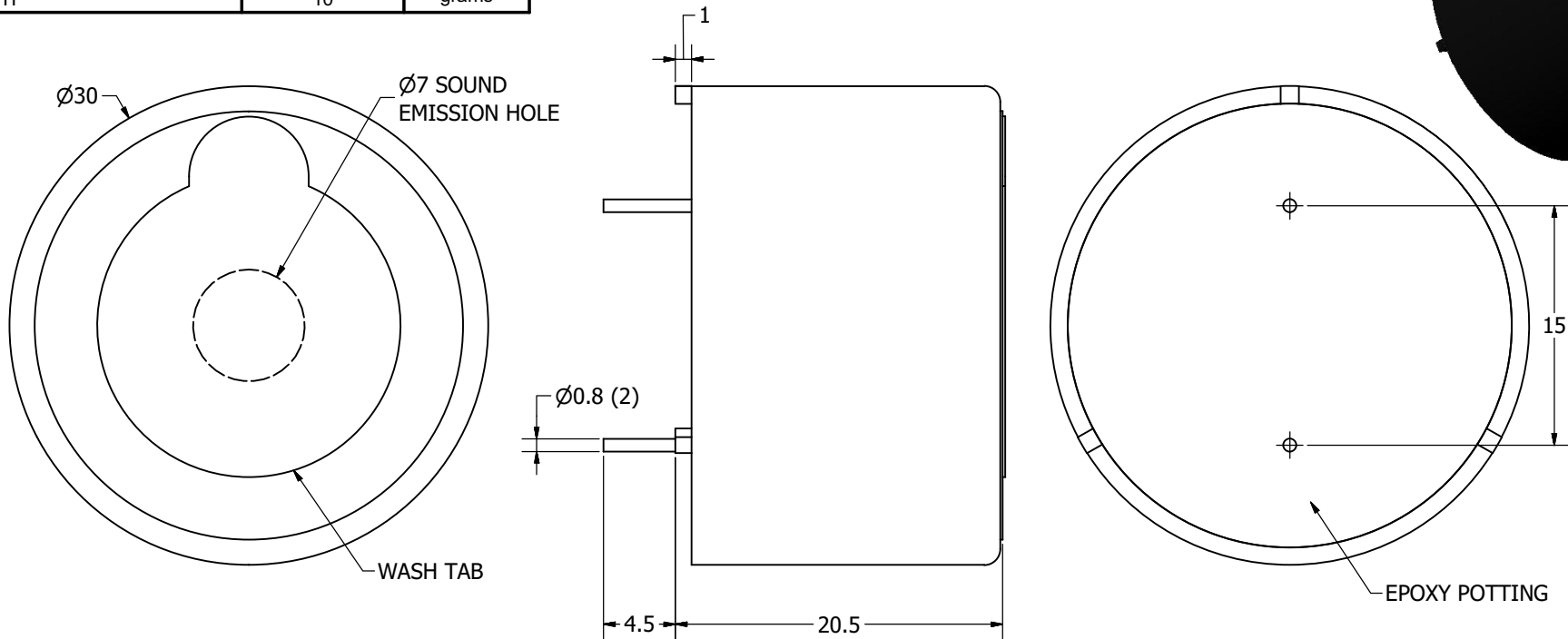

NOTES:

1. ALL DIMENSIONS ARE IN MILLIMETERS.
2. SPECIFICATIONS SUBJECT TO CHANGE OR WITHDRAWAL WITHOUT NOTICE.
3. THIS PART IS RoHS 2002/95/EC COMPLIANT.

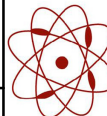
UNLESS OTHERWISE SPECIFIED: DIMENSIONS ARE IN MILLIMETERS, TOLERANCES ARE ±0.5 AND ANGLES ARE ±3°.	SIZE A3	Designed by	Date	Checked by	Date	Approved by	Date	Drawn Date
		T.G.	3/22/2006	B.R.	3/22/2006	E.P.	3/22/2006	6/14/2008
AI-3035-TWT-3V-R.idw		 pui audio a projects unlimited company				AI-3035-TWT-3V-R Indicator		
						Edition	Sheet	
						-	1 / 1	