

AC AXIAL FAN 80x80x25mm



Housing: Die-Cast Aluminum, Painted Black
 Blade: Thermoplastic PBT, UL 94V-0
 Insulation Resistance: 100M Ω , 500VDC/min between bare wire and frame
 Dielectric Strength: 1500VAC for one minute
 Operation Temperature: -10°C~70°C(Humidity 35%-85%RH)
 Storage Temperature: -40°C~85°C(Humidity 35%-85%RH)
 Motor Protection: Impedance Protected
 Weight: 250 g Packing: 60PCS/CTN



SS IP

Model Number	Voltage (VAC)	Frequency (Hz)	AirFlow (CFM)	Stat.Pres. (mm-H ₂ O)	Noise (dBA)	Speed (RPM)	Current (mA)	Power (W)	Available Bearing	Curves
FA8025B11T5-96	115	50/60	18.3/20.3	5.2/5.9	28.6/32.5	2,400/3,100	130/110	12/10	B,S	①/②
FA8025B11T7-96	115	50/60	20.3/22.3	5.7/6.4	29.6/33.5	2,500/3,200	140/120	13/11	B,S	③/④
FA8025B22T5-96	230	50/60	18.3/20.3	5.2/5.9	28.6/32.5	2,400/3,000	60/50	11/9	B,S	①/②
FA8025B22T7-96	230	50/60	20.3/22.3	5.7/6.4	29.6/33.5	2,500/3,200	65/55	12/10	B,S	③/④

- For "Sleeve" bearing version, change the "B" in the model number to "S".
- For "Wire Lead" version, change the "T" in the model number to "W".

Specifications are subject to change without notice

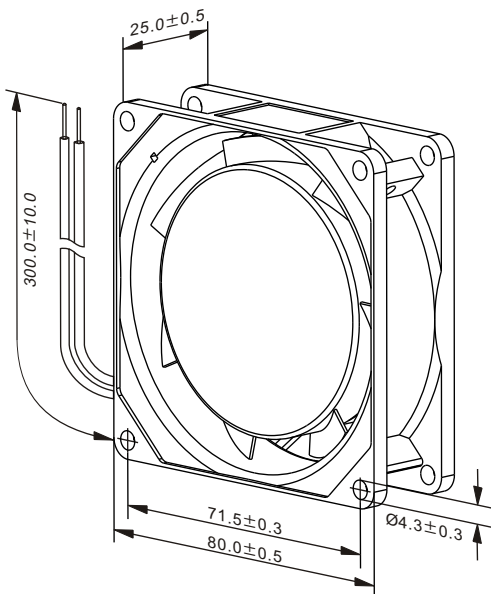

unit: mm

